



Features

- 6600 watts Peak Pulse Power
- Response Time is Typically < 1 ns
- Excellent Clamping Capability
- Glass Passivated Junction

Applications

- Power lines
- Automotive and Telecommunication
- Computers & Consumer Electronics
- Industrial Electronics

SM8S33A ----- SURFACE MOUNT TVS Diodes

General Information

VIC offers Transient Voltage Suppressor Diodes for surge and ESD protection applications, in compact chip package DO-218AB size format. The Transient Voltage Suppressor series offers a choice of Working Peak Reverse Voltage from 10 V up to 43 V and Breakdown Voltage up to 55 V.

Typical fast response times are less than 1.0 picoseconds for unidirectional devices and less than 5.0 picoseconds for bidirectional devices from 0 V to Minimum Breakdown Voltage.



Absolute Maximum Ratings

Parameter	Symbol	Value	Unit
Peak pulse power dissipation at 10/1000 μ s waveform	P_{PK}	6600	W
Peak Forward Surge Current 8.3ms single half sine-wave super	I_{FSM}	700	A
Maximum Operating temperature	T_{OPER}	-55 to +155	$^{\circ}$ C
Maximum Storage temperature	T_{STG}	-55 to +175	$^{\circ}$ C
Maximum lead temperature for soldering during 10s	T_L	260	$^{\circ}$ C

Electrical Characteristics (@ $T_A = 25^{\circ}$ C Unless Otherwise Noted)

Parameter	Symbol	Test Conditions	Min	Typ	Max	Units
Reverse Working Voltage	V_{RWM}	Any I/O pin to GND	---	---	33.0	V
Reverse Breakdown Voltage	V_{BR}	Any I/O pin to GND $I_T=5mA$	36.7	---	40.6	V
Positive Clamping Voltage	V_C	Surge waveform: 10/1000 μ s	---	---	53.3	V
Reverse Leakage Current	I_L	$V_{RWM}=33V$; $T=25^{\circ}$ C	---	---	5.0	μ A
Peak pulse Current	I_{PP}	Surge waveform: 10/1000 μ s	---	---	124	A

Product Dimensions

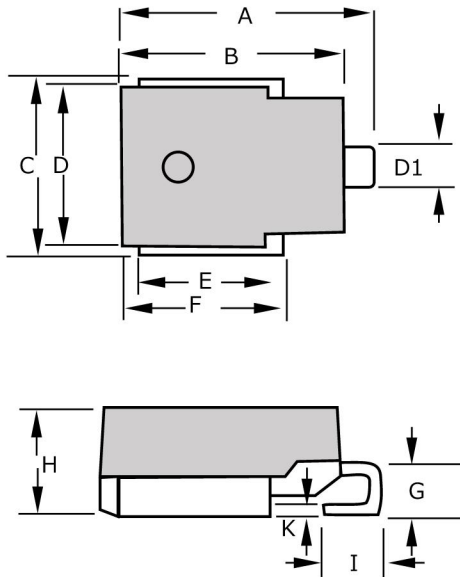

Dimension	DO-218AB
A	15.0-16.0 (0.592-0.628)
B	13.3-13.7 (0.524-0.539)
C	9.50-10.5 (0.374-0.413)
D	8.30-8.70 (0.327-0.342)
D1	2.40-3.00 (0.094-0.118)
E	8.50-9.10 (0.335-0.358)
F	9.50-10.10 (0.374-0.398)
G	2.70-3.70 (0.106-0.146)
H	4.70-5.00 (0.185-0.201)
I	1.50-2.50 (0.059-0.098)
K	0.50-0.70 (0.020-0.028)

DIMENSIONS: $\frac{\text{MM}}{\text{(INCHES)}}$

Recommended PCB Footprint

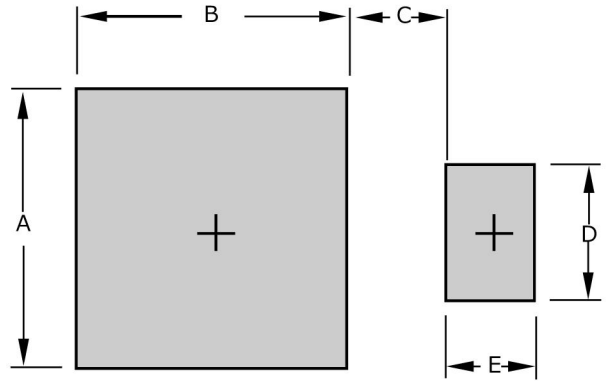

Dimension	DO-218AB
A	10.50 (0.413)
B	9.300 (0.366)
C	3.800 (0.150)
D	3.000 (0.118)
E	2.300 (0.091)

DIMENSIONS: $\frac{\text{MM}}{\text{(INCHES)}}$

Typical Protection Circuit

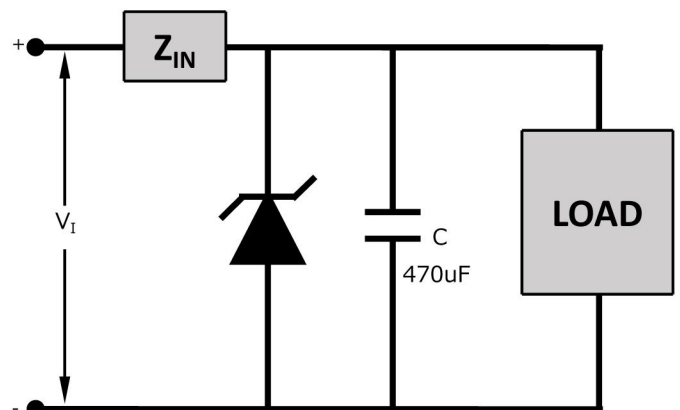



SM8S33A ----- SURFACE MOUNT TVS Diodes

Performance Graphs

Figure 1: Peak Pulse Power Rating Curve

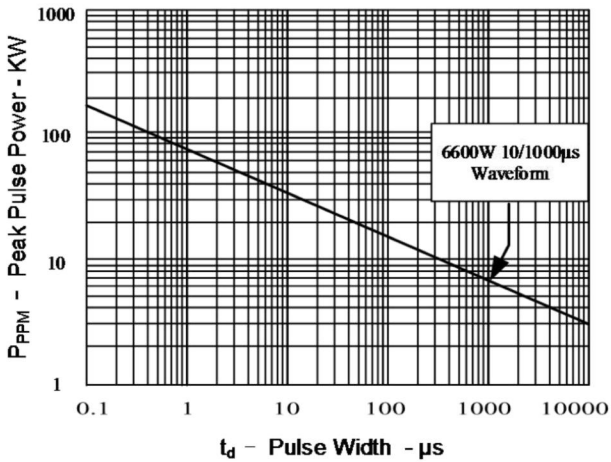

Figure 2: Pulse Derating Curve

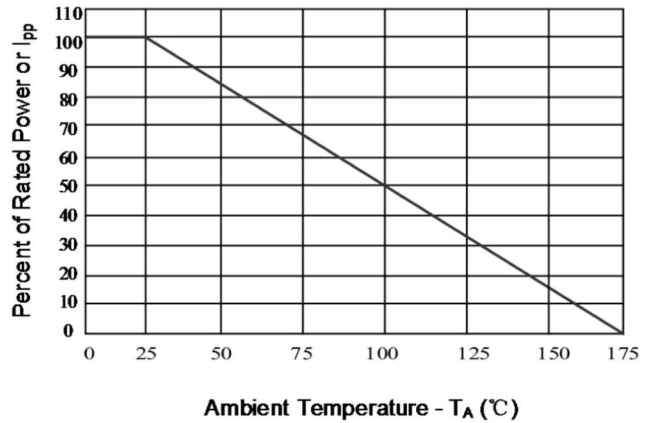

Figure 3: Pulse Waveform

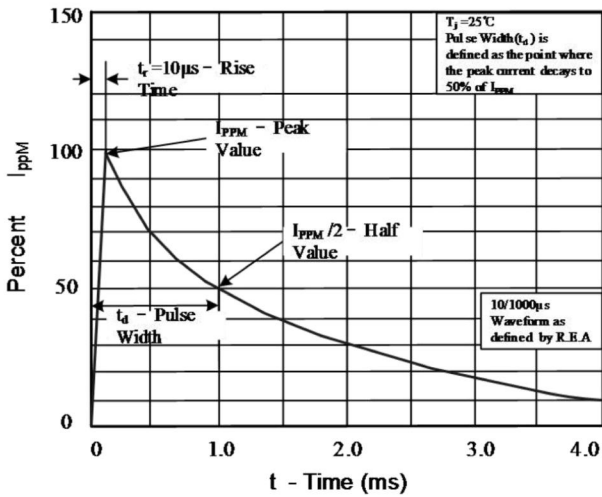

Figure 4: Typical Junction Capacitance

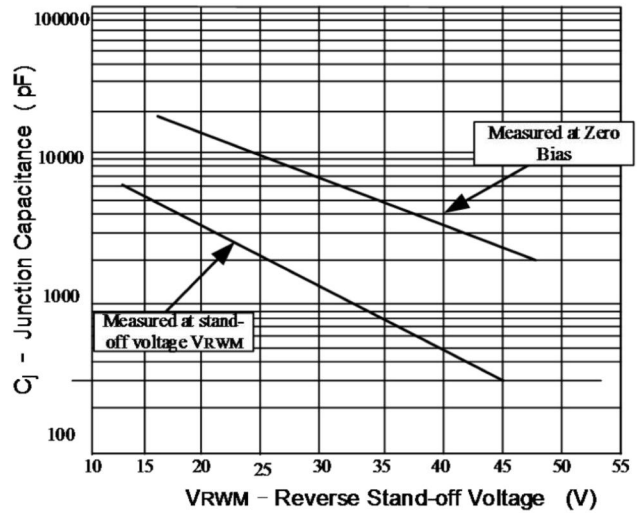

Figure 5: Steady State Power Dissipation Derating Curve

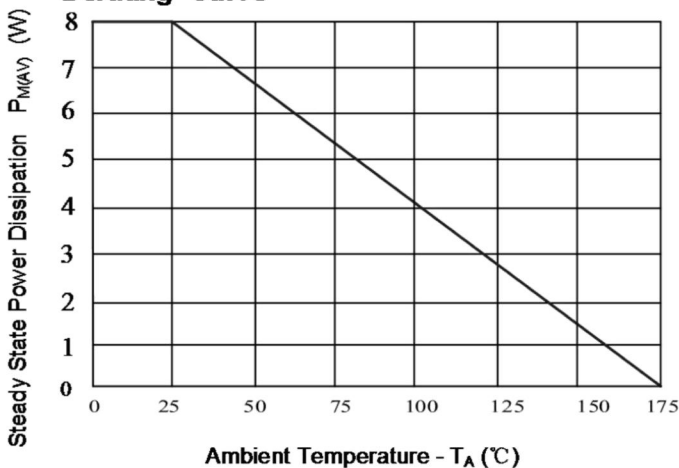
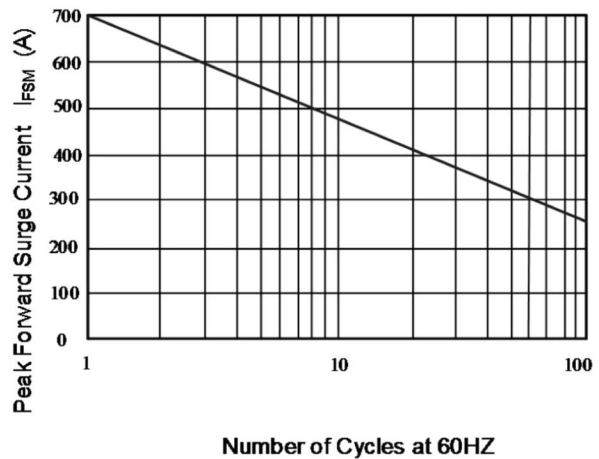
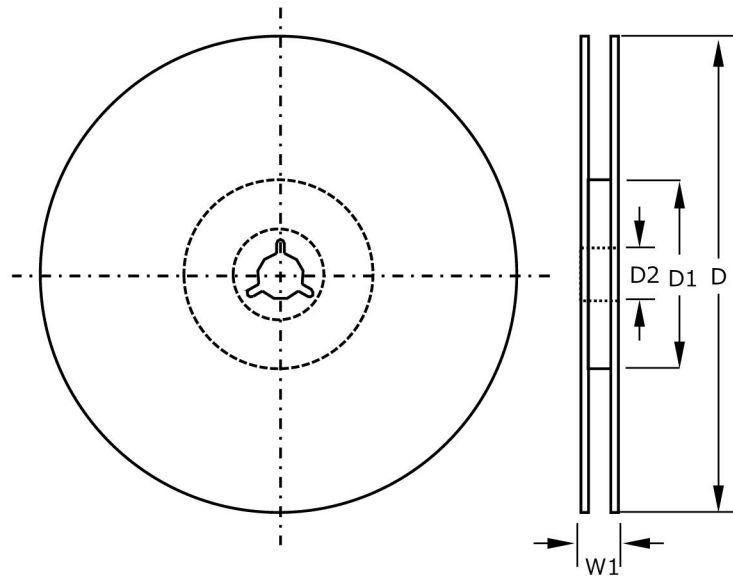
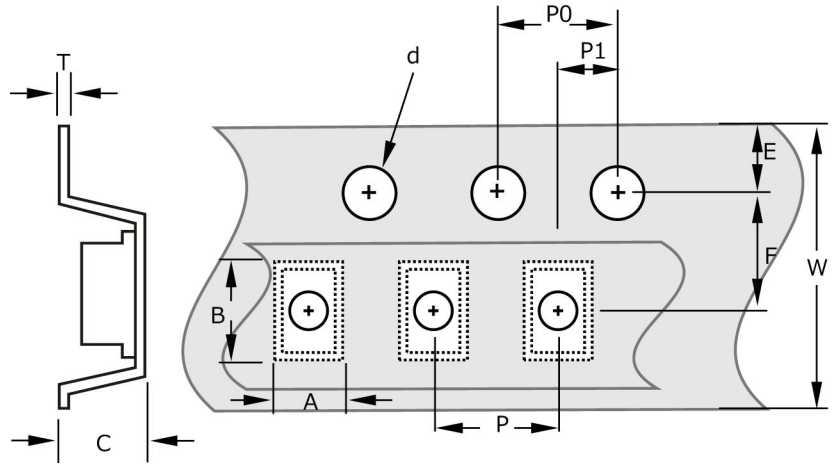

Figure 6: Maximum Non-Repetitive



Packaging Information

Symbol	DO-218AB
A	$\frac{11.0 \pm 0.5}{(0.433 \pm 0.02)}$
B	$\frac{16.0 \pm 0.50}{(0.630 \pm 0.02)}$
C	$\frac{5.0 \pm 0.50}{(0.197 \pm 0.02)}$
d	$\frac{1.50 \pm 0.10}{(0.061 \pm 0.004)}$
D	$\frac{330}{(12.992)}$
D1	$\frac{50.0}{(1.969)}$
D2	$\frac{13.0 \pm 0.20}{(0.512 \pm 0.008)}$
E	$\frac{1.75 \pm 0.10}{(0.069 \pm 0.004)}$
F	$\frac{12.0 \pm 0.5}{(0.472 \pm 0.02)}$
P	$\frac{4.00 \pm 0.10}{(0.157 \pm 0.004)}$
P0	$\frac{4.00 \pm 0.10}{(0.157 \pm 0.004)}$
P1	$\frac{2.00 \pm 0.05}{(0.079 \pm 0.002)}$
T	$\frac{0.30 \pm 0.10}{(0.012 \pm 0.004)}$
W	$\frac{24.00 \pm 0.30}{(0.945 \pm 0.012)}$
W1	$\frac{29.4}{(1.16)}$



DIMENSIONS: $\frac{\text{MM}}{(\text{INCHES})}$

Quantity of products in the taping package

- (1) Standard quantity : 750pcs/Reel for the Series.
- (2) Shipping quantity is a multiple of standard quantity.
- (3) For more information, please contact our local agents.